



# JAGUAR

## MODELS / MODELLE

|             |      |     |  |  |  |
|-------------|------|-----|--|--|--|
| Insignia    | X200 | XJ6 |  |  |  |
| Sovereign   | X250 | XK  |  |  |  |
| S-Type      | X300 | XK8 |  |  |  |
| Vanden Plas | X350 | XKR |  |  |  |
| X-Type      | X400 |     |  |  |  |
| X100        | XF   |     |  |  |  |
| X150        | XJ   |     |  |  |  |

## VIN / TYPENSCHILD

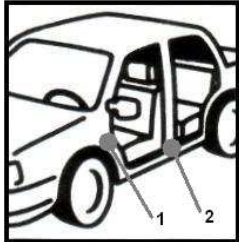
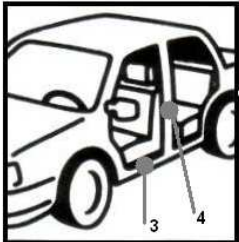
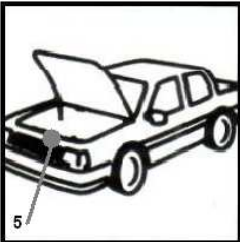
**VIN PLATE LOCATIONS**

1. XF, XJ, S-Type
2. X-Type
3. S-Type, X-Type, XJ
4. XK
5. XJ



**VIN PLATE LOCATION  
S-TYPE**





**VIN PLATE LOCATION  
X-TYPE**





**VIN PLATE JAGUAR  
PAINTCODE = PED**



# RELATED COLORS / ANBAUTEILFARBTOENE

|  |  | MODELYEAR | MODEL  |  |                  |
|--|---|-----------|--------|--|------------------|
| 712  | WESTMINSTER BLUE  | 1988-1997 |        | JUC08  | DARK BLUE        |
| 732  | SPINDRIFT WHITE   | 1996-1998 | S-TYPE | JUC03  | WHITE            |
| 734  | REGENCY RED EFFECT  | 1989-1995 |        | JUC17  | MID RED          |
| 735  | JADE GREEN EFFECT   | 1990-1998 |        | JUC09  | LIGHT GREEN      |
| 742  | GLACIER WHITE   | 1988-1995 | S-TYPE | JUC03  | WHITE            |
|  |   | 1988-1993 | XJ     | JUC03  | WHITE            |
|  |   | 1991      | XK     | JUC03  | WHITE            |
|  |   | 1988-1993 | X-TYPE | JUC03  | WHITE            |
| 748  | SIGNAL RED/BRT FIREGLOW   | 1987-1996 | XJ     | JUC18  | BRIGHT RED       |
|  |   | 1991-1996 | XK     | JUC18  | BRIGHT RED       |
|  |   | 1987      | X-TYPE | JUC18  | BRIGHT RED       |
| 750  | SILVER FROST EFFECT   | 1990-1995 | S-TYPE | JUC10  | PALE GREY        |
|  |   | 1990-1995 | XJ     | JUC10  | PALE GREY        |
|  |   | 1991      | XK     | JUC10  | PALE GREY        |
|  |   | 1990-1993 | X-TYPE | JUC10  | PALE GREY        |
| 753  | BRITISH RACING/BROOKLANDS GREEN   | 1990-1998 |        | JUC07  | DARK GREEN       |
| 765  | FLAMENCO RED EFFECT   | 1992-1995 | S-TYPE | JUC19  | RED              |
|  |   | 1992-1995 | XJ     | JUC19  | RED              |
|  |   | 1992      | XK     | JUC19  | RED              |
|  |   | 1992-1993 | X-TYPE | JUC19  | RED              |
| 778  | MOROCCO RED EFFECT  | 1991-1993 |        | JUC11  | DARK GRED BROWN  |
| 779  | KINGFISHER/DARK LAGOON EFFECT   | 1991-1003 |        | JUC07  | DARK GREEN       |
|  |   | 1991-1993 |        | JUC14  | DARK GREEN BLUE  |
| 783  | STEEL GREY EFFECT   | 1995      | S-TYPE | JUC12  | DARK GREY BEIGE  |
|  |   | 1995      | XJ     | JUC12  | DARK GREY BEIGE  |
|  |   | 1995      | XK     | JUC12  | DARK GREY BEIGE  |
| 795  | ROSE BRONZE EFFECT  | 1994-1995 | S-TYPE | JUC13  | MID BEIGE        |
|  |   | 1994-1995 | XJ     | JUC13  | MID BEIGE        |
|  |   | 1994-1995 | XK     | JUC13  | MID BEIGE        |
| 806  | SAPPHIRE BLUE EFFECT  | 1994-1998 |        | JUC08  | DARK BLUE        |
| 807  | BLACK   | 1994      | S-TYPE | JUC20  | BLACK            |
|  |   | 1994      | XJ     | JUC20  | BLACK            |
|  |   | 1994      | XK     | JUC20  | BLACK            |
|  |   | 1994      | S-TYPE | JUC08  | DARK BLUE        |
|  |   | 1994      | XJ     | JUC08  | DARK BLUE        |
|  |   | 1994      | XK     | JUC08  | DARK BLUE        |
| 810  | TITANIUM EFFECT   | 1995-1998 |        | JUC15  | DARK BLUE GREY   |
| 811  | CARNIVAL (BRIGHT RED) EFFECT  | 1996-1998 |        | JUC19  | RED              |
| 820  | PALE BEIGE EFFECT   | 1995-1998 |        | JUC15  | DARK BLUE GREY   |
|  |   | 1995-1998 |        | JUC21  | LIGHT BEIGE/GREY |
| 821  | ICE BLUE EFFECT   | 1995-1998 |        | JUC16  | LIGHT GREY BLEU  |
| 823  | SPRUCE GREEN EFFECT   | 1996-1999 |        | JUC07  | DARK GREEN       |
| 824  | NAUTILUS (BLUE/BLACK) EFFECT  | 1996-1998 |        | JUC26  | MID BLUE GREY    |
| 825  | BRIGHT TURQUOISE EFFECT   | 1995      | S-TYPE | JUC22  | TURQUOISE        |
|  |   | 1995      | XJ     | JUC22  | TURQUOISE        |
|  |   | 1995      | XK     | JUC22  | TURQUOISE        |
| 835  | SHERWOOD GREEN EFFECT   | 1997-1998 |        | JUC07  | DARK GREEN       |
| 837  | BURNISHED ORANGE EFFECT   | 1997      |        | JUC28  | ORANGE           |
| 839  | AQUAMARINE EFFECT   | 1997-1998 |        | JUC31  | MID GREEN        |
| 840  | ANTIGUA EFFECT  | 1997-1998 |        | JUC23  | MID BLUE         |
| 859  | ANTHRACITE BLACK EFFECT   | 1997-1998 |        | JUC20  | BLACK            |
| 860  | SILVER GREEN (SEAFROST) EFFECT  | 1998      |        | JUC33  | PALE GREY GREEN  |
| 861  | MISTRAL EFFECT  | 1998      |        | JUC32  | LIGHT BLUE GREEN |
|  |   | 1998      |        | JUC33  | PALE GREY GREEN  |
| 862  | PURPLE GOLD (AMARANTH) EFFECT   | 1996-1998 |        | JUC25  | PURPLE           |
| 873  | NEW STEEL GREY EFFECT   | 1996      |        | JUC12  | DARK GREY BEIGE  |
| 897  | STEEL GREY III EFFECT   | 1997      |        | JUC12  | DARK GREY BEIGE  |
| 911  | METEORITE EFFECT  | 1998      |        | JUC10  | PALE GREY        |
| 1712   | WESTMINSTER BLUE  | 2000-2002 | X-TYPE | JUC08  | DARK BLUE        |
| 1732   | SPINDRIFT   | 2000-2001 | X-TYPE | JUC03  | WHITE            |
| 1753   | BRITISH RACING GREEN  | 2002-2007 | S-TYPE | JUC07  | DARK GREEN       |
|  |   | 2002-2004 | X100   | JUC07  | DARK GREEN       |
|  |   | 2002-2005 | X200   | JUC07  | DARK GREEN       |
|  |   | 2002      | X300   | JUC07  | DARK GREEN       |
|  |   | 2002      | X400   | JUC07  | DARK GREEN       |
|  |   | 2002-2007 | XJ     | JUC07  | DARK GREEN       |
|  |   | 2002-2007 | XK     | JUC07  | DARK GREEN       |
|  |   | 2000-2004 | X-TYPE | JUC07  | DARK GREEN       |
| 1806   | SAPPHIRE EFFECT   | 2000-2002 | X-TYPE | JUC08  | DARK BLUE        |
| 1807   | EBONY   | 2003-2008 | S-TYPE | JUC20  | BLACK            |
|  |   | 2003-2008 | XJ     | JUC20  | BLACK            |
|  |   | 2003-2008 | XK     | JUC20  | BLACK            |
|  |   | 2003-2008 | X-TYPE | JUC20  | BLACK            |
| 1810   | TITANIUM EFFECT   | 2000-2001 | X-TYPE | JUC15  | DARK BLUE GREY   |
| 1811   | CARNIVAL EFFECT   | 2002      |        | JUC59  | DARK RED         |
|  |   | 2002-2003 | S-TYPE | JUC19  | RED              |
|  |   | 2002      | X100   | JUC19  | RED              |
|  |   | 2002      | X200   | JUC19  | RED              |
|  |   | 2002      | X300   | JUC19  | RED              |
|  |   | 2002      | X400   | JUC19  | RED              |
|  |   | 2002-2003 | XJ     | JUC19  | RED              |
|  |   | 2002-2003 | XK     | JUC19  | RED              |
|  |   | 2000-2002 | X-TYPE | JUC19  | RED              |
| 1820   | TOPAZ EFFECT  | 2002-2004 | X100   | JUC60  | BEIGE            |
|  |   | 2002-2004 | X200   | JUC60  | BEIGE            |
|  |   | 2002      | X300   | JUC60  | BEIGE            |
|  |   | 2004      | X350   | JUC60  | BEIGE            |
|  |   | 2002      | X400   | JUC60  | BEIGE            |
|  |   | 2002-2005 | S-TYPE | JUC21A   | LIGHT BEIGE/GREY |
|  |   | 2002-2005 | XJ     | JUC21A   | LIGHT BEIGE/GREY |
|  |   | 2002-2005 | XK     | JUC21A   | LIGHT BEIGE/GREY |
| 1823   | SPRUCE GREEN EFFECT   | 1998-1999 |        | JUC07  | DARK GREEN       |
| 1835   | SHERWOOD GREEN EFFECT   | 1998-1999 |        | JUC07  | DARK GREEN       |
| 1839   | AQUAMARINE EFFECT   | 1998      |        | JUC31  | MID GREEN        |
| 1840   | ANTIGUA BLUE EFFECT   | 1998-1999 |        | JUC23  | MID BLUE         |
| 1859   | ANTHRACITE EFFECT   | 2002      | X100   | JUC20  | BLACK            |
|  |   | 2002      | X200   | JUC20  | BLACK            |
|  |   | 2002      | X300   | JUC20  | BLACK            |
|  |   | 2002      | X400   | JUC20  | BLACK            |
|  |   | 2000-2002 | X-TYPE | JUC20  | BLACK            |



# RELATED COLORS / ANBAUTEILFARBTOENE

|  |  | MODELYEAR | MODEL     |  |                  |
|--|---|-----------|-----------|--|------------------|
| 1860   | SEAFROST EFFECT   | 2002-2007 | S-TYPE    | JUC33  | PALE GREY GREEN  |
|  |   | 2002-2004 | X100      | JUC33  | PALE GREY GREEN  |
|  |   | 2002-2004 | X200      | JUC33  | PALE GREY GREEN  |
|  |   | 2002-2007 | XJ        | JUC33  | PALE GREY GREEN  |
|  |   | 2002-2007 | XK        | JUC33  | PALE GREY GREEN  |
|  |   | 2000-2002 | X-TYPE    | JUC33  | PALE GREY GREEN  |
| 1861   | MISTRAL EFFECT  | 2000-2001 | X-TYPE    | JUC32  | LIGHT BLUE GREEN |
|  |   | 2000-2001 | X-TYPE    | JUC32  | LIGHT BLUE GREEN |
| 1862   | AMARANTH EFFECT   | 1998-1999 |           | JUC25  | PURPLE           |
| 1880   | ALPINE EFFECT   | 2000      | X-TYPE    | JUC35  | MID GREEN/BEIGE  |
| 1881   | MADEIRA EFFECT  | 1998-2002 |           | JUC19  | RED              |
| 1885   | YELLOW GREEN GREY EFFECT  | 1999      |           | JUC09  | LIGHT GREEN      |
| 1895   | EMERALD (DEEP) GREEN EFFECT   | 2000-2002 | X-TYPE    | JUC07  | DARK GREEN       |
| 1898/898   | JUPITER   | 2000-2001 | X-TYPE    | JUC18  | BRIGHT RED       |
| 1905   | PACIFIC/LAZURITE(NEUTRAL)BLUE EFFECT  | 2002      | X100      | JUC83  | BLUE             |
|  |   | 2002      | X200      | JUC83  | BLUE             |
|  |   | 2002      | X300      | JUC83  | BLUE             |
|  |   | 2002      | X400      | JUC83  | BLUE             |
|  |   | 2000-2004 | X-TYPE    | JUC83  | BLUE             |
|  |   | 2003      | SOVEREIGN | JUC08  | DARK BLUE        |
|  |   | 2003-2005 | S-TYPE    | JUC08  | DARK BLUE        |
|  |   | 2003-2005 | XJ        | JUC08  | DARK BLUE        |
|  |   | 2003-2005 | XK        | JUC08  | DARK BLUE        |
| 1907   | BLUE GOLD EFFECT  | 2000      |           | JUC32  | LIGHT BLUE GREEN |
| 1911   | METEORITE EFFECT  | 1998-1999 |           | JUC10  | PALE GREY        |
| 1916   | PLATINUM EFFECT   | 2000-2005 | S-TYPE    | JUC10  | PALE GREY        |
|  |   | 2000-2005 | XJ        | JUC10  | PALE GREY        |
|  |   | 2000-2005 | XK        | JUC10  | PALE GREY        |
|  |   | 2000-2005 | X-TYPE    | JUC10  | PALE GREY        |
| 1918   | PORCELAIN (WARM WHITE)  | 1999-2000 | X-TYPE    | JUC03  | WHITE            |
| 1921   | ROMAN BRONZE EFFECT   | 2001      | X-TYPE    | JUC46  | BRONZE           |
| 1924   | PHOENIX RED   | 2002      | X100      | JUC18  | BRIGHT RED       |
|  |   |           | X200      | JUC18  | BRIGHT RED       |
|  |   |           | X300      | JUC18  | BRIGHT RED       |
|  |   |           | X400      | JUC18  | BRIGHT RED       |
|  |   |           | XK        | JUC18  | BRIGHT RED       |
|  |   |           | X-TYPE    | JUC18  | BRIGHT RED       |
| 1926   | QUARTZ EFFECT   | 2002-2004 | X-TYPE    | JUC56  | GREY GREEN       |
|  |   | 2005-2006 | S-TYPE    | JUC56  | GREY GREEN       |
|  |   | 2005-2006 | XJ        | JUC56  | GREY GREEN       |
|  |   | 2005-2006 | XK        | JUC56  | GREY GREEN       |
| 1927   | ZIRCON (PALE BLUE) EFFECT   | 2005-2007 | S-TYPE    | JUC32  | LIGHT BLUE GREEN |
|  |   | 2005-2007 | XJ        | JUC32  | LIGHT BLUE GREEN |
|  |   | 2005-2007 | XK        | JUC32  | LIGHT BLUE GREEN |
|  |   | 2002-2004 | X-TYPE    | JUC32  | LIGHT BLUE GREEN |
| 1932   | ADRIATIC BLUE EFFECT  | 2003      | S-TYPE    | JUC55  | BLUE GREEN       |
|  |   | 2001-2003 | X-TYPE    | JUC55  | BLUE GREEN       |
| 1942   | ONYX WHITE  | 2002-2006 | S-TYPE    | JUC03  | WHITE            |
|  |   | 2002      | X100      | JUC03  | WHITE            |
|  |   | 2002      | X200      | JUC03  | WHITE            |
|  |   | 2002      | X300      | JUC03  | WHITE            |
|  |   | 2002-2006 | XJ        | JUC03  | WHITE            |
|  |   | 2002-2006 | XK        | JUC03  | WHITE            |
|  |   | 2001-2007 | X-TYPE    | JUC03  | WHITE            |
| 1943   | SLATE GREY EFFECT   | 2002-2007 | S-TYPE    | JUC15  | DARK BLUE GREY   |
|  |   | 2002-2007 | XJ        | JUC15  | DARK BLUE GREY   |
|  |   | 2002-2007 | XK        | JUC15  | DARK BLUE GREY   |
| 1945   | ASPEN GREEN EFFECT  | 200&      | X-TYPE    | JUC07  | DARK GREEN       |
| 1948   | DARK BLUE EFFECT  | 2001-2003 | X-TYPE    | JUC08  | DARK BLUE        |
| 1950   | BLUE EFFECT   | 2003      | X-TYPE    | JUC08  | DARK BLUE        |
| 1951   | MID GREY BLUE EFFECT  | 2002      | X-TYPE    | JUC32  | LIGHT BLUE GREEN |
| 1953   | TEMPEST EFFECT  | 2003      |           | JUC53  | BLUE PURPLE      |
| 1954   | GARNET EFFECT   | 2002      |           | JUC52  | DARK RED PURPLE  |
| 1955 (I)   | MIRAGE (NEUTRAL) SILVER EFFECT  | 2003      |           | JUC10  | PALE GREY        |
| 1956   | LIGHT GREY GOLD EFFECT  | 2003      | X-TYPE    | JUC21A   | LIGHT BEIGE/GREY |
| 1957   | JAGUAR RACING (JASPER) GREEN EFFECT   | 2005-2008 | S-TYPE    | JUC51  | YELLOW GREEN     |
|  |   | 2004      | X100      | JUC51  | YELLOW GREEN     |
|  |   | 2004      | X200      | JUC51  | YELLOW GREEN     |
|  |   | 2004      | X350      | JUC51  | YELLOW GREEN     |
|  |   | 2004      | X400      | JUC51  | YELLOW GREEN     |
|  |   | 2005-2008 | XJ        | JUC51  | YELLOW GREEN     |
|  |   | 2005-2008 | XK        | JUC51  | YELLOW GREEN     |
|  |   | 2007      | X-TYPE    | JUC51  | YELLOW GREEN     |
| 1959 (I)   | MIDNIGHT (BLUE BLACK) EFFECT  | 2004      | X100      | JUC20  | BLACK            |
|  |   | 2004      | X200      | JUC20  | BLACK            |
|  |   | 2004      | X350      | JUC20  | BLACK            |
|  |   | 2003-2008 | S-TYPE    | JUC20  |                  |
|  |   | 2003-2008 | XJ        | JUC20  | BLACK            |
|  |   | 2003-2008 | XK        | JUC20  | BLACK            |
|  |   | 2003-2008 | X-TYPE    | JUC20  |                  |
| 1963   | ALTERNATIVE TOPAZ EFFECT  | 2001-2003 | X-TYPE    | JUC21A   | LIGHT BEIGE/GREY |
| 1964   | SALSA   | 2003-2008 | S-TYPE    | JUC18  | BRIGHT RED       |
|  |   | 2005-2008 | XJ        | JUC18  | BRIGHT RED       |
|  |   | 2005-2008 | XK        | JUC18  | BRIGHT RED       |
|  |   | 2004-2005 | X-TYPE    | JUC61  | RED              |
| 1968   | AQUA GREEN EFFECT   | 2004      |           | JUC66  | PALE BLUE        |
| 1972   | RED BLUISH GREY EFFECT  | 2004      | S-TYPE    | JUC64  | PURPLE           |
|  |   | 2004      | X-TYPE    | JUC64  | PURPLE           |
| 1974A  | ULTRAVIOLET/BLUES BLUE EFFECT   | 2005-2006 | S-TYPE    | JUC63  | MEDIUM BLUE      |
|  |   | 2005      | XJ        | JUC63  | MEDIUM BLUE      |
|  |   | 2005      | XK        | JUC63  | MEDIUM BLUE      |
| 1975   | RADIANCE EFFECT   | 2005-2007 | S-TYPE    | JUC62  | BURGUNDY         |
|  |   | 2005-2007 | XJ        | JUC62  | BURGUNDY         |
|  |   | 2005-2007 | XK        | JUC62  | BURGUNDY         |
|  |   | 2004      | X-TYPE    | JUC62  | BURGUNDY         |
| 2001   | PERSIAN/DEEP(INTENSITY)RED EFFECT   | 2008      | S-TYPE    | JUC62  | BURGUNDY         |
|  |   | 2008      | XJ        | JUC62  | BURGUNDY         |
|  |   | 2008      | XK        | JUC62  | BURGUNDY         |
| 2002   | WINTER GOLD EFFECT  | 2006-2008 | S-TYPE    | JUC85  | WINTER GOLD      |
|  |   | 2006-2009 | XJ        | JUC85  | WINTER GOLD      |
|  |   | 2006-2009 | XK        | JUC85  | WINTER GOLD      |
|  |   | 2007-2009 | X-TYPE    | JUC85  | WINTER GOLD      |



# RELATED COLORS / ANBAUTEILFARBTOENE

|  |  | MODELYEAR | MODEL  |  |                       |
|--|---|-----------|--------|--|-----------------------|
| 2003   | INDIGO EFFECT   | 2006-2008 | S-TYPE | JUC86  | INDIGO                |
|  |   | 2006-2010 | XJ     | JUC86  | INDIGO                |
| 2023   | PORCELAIN WHITE   | 2006-2010 | XK     | JUC86  | INDIGO                |
|  |   | 2006-2008 | X-TYPE | JUC86  | INDIGO                |
|  |   | 2007-200  | S-TYPE | JUC98  | PORCELAIN             |
|  |   | 2007-2010 | XJ     | JUC98  | PORCELAIN             |
| 2028   | LUNAR GREY EFFECT   | 2007-2010 | XK     | JUC98  | PORCELAIN             |
|  |   | 2007-2010 | X-TYPE | JUC98  | PORCELAIN             |
|  |   | 2007-2008 | S-TYPE | JUC97  | LUNAR GREY            |
|  |   | 2007-2011 | XJ     | JUC97  | LUNAR GREY            |
| 2029   | LIQUID SILVER EFFECT  | 2007-2011 | XK     | JUC97  | LUNAR GREY            |
|  |   | 2007-2008 | X-TYPE | JUC97  | LUNAR GREY            |
|  |   | 2006-2008 | S-TYPE | JUC87  | LIQUID SILVER/ZERMATT |
|  |   | 2006-2011 | XJ     | JUC87  | LIQUID SILVER/ZERMATT |
| 2030   | GUNMETAL EFFECT   | 2006-2010 | XK     | JUC87  | LIQUID SILVER/ZERMATT |
|  |   | 2006-2010 | X-TYPE | JUC87  | LIQUID SILVER/ZERMATT |
|  |   | 2008      | S-TYPE | JUC15  | DARK BLUE GREY        |
|  |   | 2008      | XF     | JUC101   | PEARL GREY            |
| 2038A  | MEDIUM FRESCO BLUE EFFECT   | 2010      | XJ     | JUC15  | DARK BLUE GREY        |
|  |   | 2008      | XJ     | JUC101   | PEARL GREY            |
|  |   | 2010      | XK     | JUC15  | DARK BLUE GREY        |
|  |   | 2008      | XK     | JUC101   | PEARL GREY            |
| 2039   | CRYSTAL BLUE EFFECT   | 2008      | S-TYPE | JUC101   | CRYSTAL BLUE          |
|  |   | 2008-2009 | XJ     | JUC101   | CRYSTAL BLUE          |
|  |   | 2008-2009 | XK     | JUC101   | CRYSTAL BLUE          |
| 2041   | VAPOUR EFFECT   | 2008      | S-TYPE | JUC56  | GREY GREEN            |
|  |   | 2008      | S-TYPE | JUC106   | VAPOUR GREY           |
|  |   | 2008      | XF     | JUC106   | VAPOUR GREY           |
|  |   | 2008-2011 | XJ     | JUC56  | GREY GREEN            |
|  |   | 2008-2011 | XJ     | JUC106   | VAPOUR GREY           |
|  |   | 2008-2011 | XK     | JUC56  | GREY GREEN            |
|  |   | 2008-2011 | XK     | JUC106   | VAPOUR GREY           |
| 2044   | EVERGREEN (BOTANICAL GREEN) EFFECT  | 2008      | X250   | JUC106   | VAPOUR GREY           |
|  |   | 2008      | S-TYPE | JUC07  | DARK GREEN            |
|  |   | 2008      | S-TYPE | JUC103   | BOTANICAL GREEN       |
|  |   | 2008      | XF     | JUC103   | BOTANICAL GREEN       |
|  |   | 2008-2011 | XJ     | JUC07  | DARK GREEN            |
|  |   | 2008-2011 | XJ     | JUC103   | BOTANICAL GREEN       |
|  |   | 2008-2011 | XK     | JUC07  | DARK GREEN            |
| 2053   | FROST BLUE EFFECT   | 2008-2011 | XK     | JUC103   | BOTANICAL GREEN       |
|  |   | 2008      | X-TYPE | JUC07  | DARK GREEN            |
|  |   | 2008      | X-TYPE | JUC103   | BOTANICAL GREEN       |
|  |   | 2007      | S-TYPE | JUC99  | FROST BLUE            |
|  |   | 2007-2010 | XJ     | JUC99  | FROST BLUE            |
|  |   | 2007-2010 | XK     | JUC99  | FROST BLUE            |
|  |   | 2006      | X-TYPE | JUC99  | FROST BLUE            |
| 2074   | EMERALD FIRE EFFECT   | 2007-2008 | S-TYPE | JUC100   | EMERALD FIRE          |
|  |   | 2007-2009 | XJ     | JUC100   | EMERALD FIRE          |
|  |   | 2007-2009 | XK     | JUC100   | EMERALD FIRE          |
| 2076   | GLACIER BLUE EFFECT   | 2007-2010 | X-TYPE | JUC93  | IZMIR                 |
| 2077   | CHILLI RED EFFECT   | 2007-2010 | X-TYPE | JUC90  | RIMINI RED            |
| 2078   | SHADOW GREY EFFECT  | 2007-2010 | X-TYPE | JUC89  | STORNOWAY             |
| BDE  | ROMAN BRONZE EFFECT   | 2001      | X-TYPE | JUC46  | BRONZE                |
| CEX  | GARNET EFFECT   | 2002      |        | JUC52  | DARK RED PURPLE       |
| CFA  | REGENCY RED EFFECT  | 1989-1995 |        | JUC17  | MID RED               |
| CFC  | SIGNAL RED/BRT FIREGLOW   | 1987-1996 | XJ     | JUC18  | BRIGHT RED            |
|  |   | 1991-1996 | XK     | JUC18  | BRIGHT RED            |
|  |   | 1987      | X-TYPE | JUC18  | BRIGHT RED            |
| CFG  | MOROCCO RED EFFECT  | 1991-1993 |        | JUC11  | DARK RED BROWN        |
| CFH  | FLAMENCO RED EFFECT   | 1992-1995 | S-TYPE | JUC19  | RED                   |
|  |   | 1992-1995 | XJ     | JUC19  | RED                   |
|  |   | 1992      | XK     | JUC19  | RED                   |
|  |   | 1992-1993 | X-TYPE | JUC19  | RED                   |
|  |   | 1996-1998 |        | JUC19  | RED                   |
| CFS  | CARNIVAL (BRIGHT RED) EFFECT  | 1996-1998 |        | JUC19  | RED                   |
| CGG  | CARNIVAL EFFECT   | 2002      |        | JUC59  | DARK RED              |
|  |   | 2002-2003 | S-TYPE | JUC19  | RED                   |
|  |   | 2002      | X100   | JUC19  | RED                   |
|  |   | 2002      | X200   | JUC19  | RED                   |
|  |   | 2002      | X300   | JUC19  | RED                   |
|  |   | 2002      | X400   | JUC19  | RED                   |
|  |   | 2002-2003 | XJ     | JUC19  | RED                   |
|  |   | 2002-2003 | XK     | JUC19  | RED                   |
|  |   | 2000-2002 | X-TYPE | JUC19  | RED                   |
|  |   | 1998-2002 |        | JUC19  | RED                   |
| CGH  | MADEIRA EFFECT  | 1998-2002 |        | JUC19  | RED                   |
| CGJ  | JUPITER   | 2000-2001 | X-TYPE | JUC18  | BRIGHT RED            |
| CGL  | PHOENIX RED   | 2002      | X100   | JUC18  | BRIGHT RED            |
|  |   | 2002      | X200   | JUC18  | BRIGHT RED            |
|  |   | 2002      | X300   | JUC18  | BRIGHT RED            |
|  |   | 2002      | X400   | JUC18  | BRIGHT RED            |
|  |   | 2002-2003 | XK     | JUC18  | BRIGHT RED            |
|  |   | 2001-2003 | X-TYPE | JUC18  | BRIGHT RED            |
| CGX  | GARNET EFFECT   | 2002      |        | JUC52  | DARK RED PURPLE       |
| CHA  | SALSA   | 2003-2004 | S-TYPE | JUC18  | BRIGHT RED            |
|  |   | 2005-2008 | XJ     | JUC18  | BRIGHT RED            |
|  |   | 2005-2008 | XK     | JUC18  | BRIGHT RED            |
| CHB  | RADIANCE EFFECT   | 2004-2005 | X-TYPE | JUC61  | RED                   |
|  |   | 2005-2007 | S-TYPE | JUC62  | BURGUNDY              |
|  |   | 2005-2007 | XJ     | JUC62  | BURGUNDY              |
|  |   | 2005-2007 | XK     | JUC62  | BURGUNDY              |
| CHG  | CHILLI RED EFFECT   | 2004      | X-TYPE | JUC62  | BURGUNDY              |
|  |   | 2007-2010 | X-TYPE | JUC90  | RIMINI RED            |
| CHL  | PERSIAN/DEEP(INTENSITY)RED EFFECT   | 2008      | S-TYPE | JUC62  | BURGUNDY              |
|  |   | 2008      | XJ     | JUC62  | BURGUNDY              |
| EDD  | BURNISHED ORANGE EFFECT   | 2008      | XK     | JUC62  | BURGUNDY              |
|  |   | 1997      |        | JUC28  | ORANGE                |
| GDM  | WINTER GOLD EFFECT  | 2006-2008 | S-TYPE | JUC85  | WINTER GOLD           |
|  |   | 2006-2009 | XJ     | JUC85  | WINTER GOLD           |
|  |   | 2006-2009 | XK     | JUC85  | WINTER GOLD           |
|  |   | 2006-2009 | X-TYPE | JUC85  | WINTER GOLD           |



# RELATED COLORS / ANBAUTEILFARBTOENE

|  |  | MODELYEAR | MODEL  |  |                  |
|--|---|-----------|--------|--|------------------|
| HEV  | JADE GREEN EFFECT   | 1990-1998 |        | JUC09  | LIGHT GREEN      |
| HFB  | BRITISH RACING/BROOKLANDS GREEN   | 1990-1998 |        | JUC07  | DARK GREEN       |
| HFE  | KINGFISHER/DARK LAGOON EFFECT   | 1991-1003 |        | JUC07  | DARK GREEN       |
|  |   | 1991-1993 |        | JUC14  | DARK GREEN BLUE  |
| HFL  | SPRUCE GREEN EFFECT   | 1996-1999 |        | JUC07  | DARK GREEN       |
| HFR  | SHERWOOD GREEN EFFECT   | 1997-1998 |        | JUC07  | DARK GREEN       |
| HGD  | BRITISH RACING GREEN  | 2002-2007 | S-TYPE | JUC07  | DARK GREEN       |
|  |   | 2002-2004 | X100   | JUC07  | DARK GREEN       |
|  |   | 2002-2005 | X200   | JUC07  | DARK GREEN       |
|  |   | 2002      | X300   | JUC07  | DARK GREEN       |
|  |   | 2002      | X400   | JUC07  | DARK GREEN       |
|  |   | 2002-2007 | XJ     | JUC07  | DARK GREEN       |
|  |   | 2002-2007 | XK     | JUC07  | DARK GREEN       |
|  |   | 2000-2004 | X-TYPE | JUC07  | DARK GREEN       |
| HGE  | SHERWOOD GREEN EFFECT   | 1998-1999 |        | JUC07  | DARK GREEN       |
| HGF  | ALPINE EFFECT   | 2000      | X-TYPE | JUC36  | GREEN/BEIGE      |
| HGG  | EMERALD (DEEP) GREEN EFFECT   | 2000-2002 | X-TYPE | JUC07  | DARK GREEN       |
| HGL  | SPRUCE GREEN EFFECT   | 1998-1999 |        | JUC07  | DARK GREEN       |
| HGN/JJM  | ADRIATIC BLUE EFFECT  | 2003      | S-TYPE | JUC55  | BLUE GREEN       |
|  |   | 2001-2003 | X-TYPE | JUC55  | BLUE GREEN       |
| HGP  | ASPEN GREEN EFFECT  | 200&      | X-TYPE | JUC07  | DARK GREEN       |
| HGZ  | JAGUAR RACING (JASPER) GREEN EFFECT   | 2005-2008 | S-TYPE | JUC51  | YELLOW GREEN     |
|  |   | 2004      | X100   | JUC51  | YELLOW GREEN     |
|  |   | 2004      | X200   | JUC51  | YELLOW GREEN     |
|  |   | 2004      | X350   | JUC51  | YELLOW GREEN     |
|  |   | 2004      | X400   | JUC51  | YELLOW GREEN     |
|  |   | 2005-2008 | XJ     | JUC51  | YELLOW GREEN     |
|  |   | 2005-2008 | XK     | JUC51  | YELLOW GREEN     |
|  |   | 2007      | X-TYPE | JUC51  | YELLOW GREEN     |
| HHN  | BOTANICAL GREEN EFFECT  | 2008      | S-TYPE | JUC07  | DARK GREEN       |
|  |   | 2008-2011 | XJ     | JUC07  | DARK GREEN       |
|  |   | 2008-2011 | XK     | JUC07  | DARK GREEN       |
| HHP  | EMERALD FIRE EFFECT   | 2007-2008 | S-TYPE | JUC100   | EMERALD FIRE     |
|  |   | 2007-2009 | XJ     | JUC100   | EMERALD FIRE     |
|  |   | 2007-2009 | XK     | JUC100   | EMERALD FIRE     |
| HNN  | EVERGREEN (BOTANICAL GREEN) EFFECT  | 2008      | S-TYPE | JUC103   | BOTANICAL GREEN  |
|  |   | 2008      | X-TYPE | JUC07  | DARK GREEN       |
|  |   | 2008      | X-TYPE | JUC103   | BOTANICAL GREEN  |
|  |   | 2008      | XF     | JUC103   | BOTANICAL GREEN  |
|  |   | 2008      | XJ     | JUC103   | BOTANICAL GREEN  |
|  |   | 2008      | XK     | JUC103   | BOTANICAL GREEN  |
| JFG  | WESTMINSTER BLUE  | 1988-1997 |        | JUC08  | DARK BLUE        |
|  |   | 198-1999  |        | JUC08  | DARK BLUE        |
| JGE  | SAPPHIRE BLUE EFFECT  | 1994-1998 |        | JUC08  | DARK BLUE        |
|  |   | 1994-1998 |        | JUC08  | DARK BLUE        |
| JGY  | AQUAMARINE EFFECT   | 1997-1998 |        | JUC31  | MID GREEN        |
| JGZ  | ANTIGUA EFFECT  | 1997-1998 |        | JUC23  | BLUE             |
| JHA  | MISTRAL EFFECT  | 1998      |        | JUC32  | LIGHT BLUE GREEN |
|  |   | 1998      |        | JUC33  | PALE GREY GREEN  |
| JHE  | SAPPHIRE EFFECT   | 2000-2002 | X-TYPE | JUC08  | DARK BLUE        |
| JHF  | AQUAMARINE EFFECT   | 1998      |        | JUC31  | MID GREEN        |
| JHG  | WESTMINSTER BLUE  | 2000-2002 | X-TYPE | JUC08  | DARK BLUE        |
| JHH  | ANTIGUA BLUE EFFECT   | 1998-1999 |        | JUC23  | BLUE             |
| JHJ  | MISTRAL EFFECT  | 2000-2001 | X-TYPE | JUC32  | LIGHT BLUE GREEN |
| JHM  | PACIFIC/LAZURITE(NEUTRAL)BLUE EFFECT  | 2002      | X100   | JUC83  | BLUE             |
|  |   | 2002      | X200   | JUC83  | BLUE             |
|  |   | 2002      | X300   | JUC83  | BLUE             |
|  |   | 2002      | X400   | JUC83  | BLUE             |
|  |   | 2000-2004 | X-TYPE | JUC83  | BLUE             |
|  |   | 2003-2005 | S-TYPE | JUC08  | DARK BLUE        |
|  |   | 2003-2005 | XJ     | JUC08  | DARK BLUE        |
|  |   | 2003-2005 | XK     | JUC08  | DARK BLUE        |
| JHV  | ZIRCON (PALE BLUE) EFFECT   | 2005-2007 | XJ     | JUC32  | LIGHT BLUE GREEN |
|  |   | 2005-2007 | XK     | JUC32  | LIGHT BLUE GREEN |
|  |   | 2002-2004 | X-TYPE | JUC32  | LIGHT BLUE GREEN |
|  |   | 2002-2004 | X-TYPE | JUC32  | LIGHT BLUE GREEN |
| JHZ  | TEMPEST EFFECT  | 2003      |        | JUC53  | BLUE PURPLE      |
| JJA  | BLUE EFFECT   | 2003      | X-TYPE | JUC08  | DARK BLUE        |
|  |   | 2003      | X-TYPE | JUC08  | DARK BLUE        |
| JJB  | DARK BLUE EFFECT  | 2001-2003 | X-TYPE | JUC08  | DARK BLUE        |
| JJF  | ULTRAVIOLET/BLUES BLUE EFFECT   | 2005-2006 | S-TYPE | JUC63  | MEDIUM BLUE      |
|  |   | 2005      | XJ     | JUC63  | MEDIUM BLUE      |
|  |   | 2005      | XK     | JUC63  | MEDIUM BLUE      |
| JJX  | INDIGO EFFECT   | 2006-2008 | S-TYPE | JUC86  | INDIGO           |
|  |   | 2006-2010 | XJ     | JUC86  | INDIGO           |
|  |   | 2006-2010 | XK     | JUC86  | INDIGO           |
|  |   | 2006-2008 | X-TYPE | JUC86  | INDIGO           |
| JJZ  | FROST BLUE EFFECT   | 2007      | S-TYPE | JUC99  | FROST BLUE       |
|  |   | 2007-2010 | XJ     | JUC99  | FROST BLUE       |
|  |   | 2007-2010 | XK     | JUC99  | FROST BLUE       |
|  |   | 2006      | X-TYPE | JUC99  | FROST BLUE       |
| JKE  | MEDIUM FRESCO BLUE EFFECT   | 2008      | S-TYPE | JUC10  | PALE GREY        |
|  |   | 2008-2009 | XJ     | JUC10  | PALE GREY        |
|  |   | 2008-2009 | XK     | JUC10  | PALE GREY        |
| JKF  | CRYSTAL BLUE EFFECT   | 2008      | S-TYPE | JUC101   | CRYSTAL BLUE     |
|  |   | 2008-2011 | XJ     | JUC101   | CRYSTAL BLUE     |
|  |   | 2008-2011 | XK     | JUC101   | CRYSTAL BLUE     |
| JKH  | GLACIER BLUE EFFECT   | 2007-2008 | X-TYPE | JUC93  | IZMIR            |
| JKK  | GLACIER BLUE EFFECT   | 2007-2010 | X-TYPE | JUC93  | IZMIR            |
| KDJ  | PURPLE GOLD (AMARANTH) EFFECT   | 1996-1998 |        | JUC25  | PURPLE           |
| KDK  | AMARANTH EFFECT   | 1998-1999 |        | JUC25  | PURPLE           |
|  |   | 1998      |        | JUC25  | PURPLE           |
| KDV  | RED BLUISH GREY EFFECT  | 2004      | S-TYPE | JUC64  | PURPLE           |
|  |   | 2004      | X-TYPE | JUC64  | PURPLE           |
| LEV  | STEEL GREY EFFECT   | 1995      | S-TYPE | JUC12  | DARK GREY BEIGE  |
|  |   | 1995      | XJ     | JUC12  | DARK GREY BEIGE  |
|  |   | 1995      | XK     | JUC12  | DARK GREY BEIGE  |
| LFA  | TITANIUM EFFECT   | 1995-1998 |        | JUC15  | DARK BLUE GREY   |
| LFB  | TURQUOISE GREY EFFECT   | 1995-1996 |        | JUC22  | TURQUOISE        |
| LGB  | NEW STEEL GREY EFFECT   | 1996      |        | JUC12  | DARK GREY BEIGE  |
| LGF  | STEEL GREY III EFFECT   | 1997      |        | JUC12  | DARK GREY BEIGE  |
| LGL  | TITANIUM EFFECT   | 2000-2001 | X-TYPE | JUC15  | DARK BLUE GREY   |
| LHK  | QUARTZ EFFECT   | 2002-2004 | X-TYPE | JUC56  | GREY GREEN       |



# RELATED COLORS / ANBAUTEILFARBTOENE

|  |  | MODELYEAR | MODEL  |  |                       |
|--|---|-----------|--------|--|-----------------------|
| LHL  | SLATE GREY EFFECT   | 2002-2007 | S-TYPE | JUC15  | DARK BLUE GREY        |
|  |   | 2002-2007 | XJ     | JUC15  | DARK BLUE GREY        |
|  |   | 2002-2007 | XK     | JUC15  | DARK BLUE GREY        |
| LHT  | AQUA GREEN EFFECT   | 2004      |        | JUC86  | PALE BLUE             |
| LJZ  | LUNAR GREY EFFECT   | 2007-2008 | S-TYPE | JUC97  | LUNAR GREY            |
|  |   | 2007-2011 | XJ     | JUC97  | LUNAR GREY            |
|  |   | 2007-2011 | XK     | JUC97  | LUNAR GREY            |
|  |   | 2007-2008 | X-TYPE | JUC97  | LUNAR GREY            |
| LMN  | GUNMETAL EFFECT   | 2008      | S-TYPE | JUC15  | DARK BLUE GREY        |
|  |   | 2008      | XF     | JUC101   | PEARL GREY            |
|  |   | 2008-2010 | XJ     | JUC15  | DARK BLUE GREY        |
|  |   | 2008      | XJ     | JUC101   | PEARL GREY            |
|  |   | 2008-2010 | XK     | JUC15  | DARK BLUE GREY        |
|  |   | 2008      | XK     | JUC101   | PEARL GREY            |
| LMO  | VAPOUR EFFECT   | 2008      | S-TYPE | JUC56  | GREY GREEN            |
|  |   | 2008      | S-TYPE | JUC106   | VAPOUR GREY           |
|  |   | 2008      | XF     | JUC106   | VAPOUR GREY           |
|  |   | 2008-2011 | XJ     | JUC56  | GREY GREEN            |
|  |   | 2008-2011 | XJ     | JUC106   | VAPOUR GREY           |
|  |   | 2008-2011 | XK     | JUC56  | GREY GREEN            |
|  |   | 2008-2011 | XK     | JUC106   | VAPOUR GREY           |
|  |   | 2008      | X250   | JUC106   | VAPOUR GREY           |
| LMR  | SHADOW GREY EFFECT  | 2007-2010 | X-TYPE | JUC89  | STORNOWAY             |
| MDK  | SILVER FROST EFFECT   | 1990-1995 | S-TYPE | JUC10  | PALE GREY             |
|  |   | 1990-1995 | XJ     | JUC10  | PALE GREY             |
|  |   | 1991      | XK     | JUC10  | PALE GREY             |
|  |   | 1990-1993 | X-TYPE | JUC10  | PALE GREY             |
| MDP  | ICE BLUE EFFECT   | 1995-1998 |        | JUC16  | LT GREY BLUE          |
| MDS  | SILVER GREEN (SEAFROST) EFFECT  | 1998      |        | JUC33  | PALE GREY GREEN       |
| MDT  | METEORITE EFFECT  | 1998      |        | JUC10  | PALE GREY             |
| MDV  | SEAFROST EFFECT   | 2002-2007 | S-TYPE | JUC33  | PALE GREY GREEN       |
|  |   | 2002-2004 | X100   | JUC33  | PALE GREY GREEN       |
|  |   | 2002-2004 | X200   | JUC33  | PALE GREY GREEN       |
|  |   | 2002-2007 | XJ     | JUC33  | PALE GREY GREEN       |
|  |   | 2002-2007 | XK     | JUC33  | PALE GREY GREEN       |
|  |   | 2000-2002 | X-TYPE | JUC33  | PALE GREY GREEN       |
| MDX  | METEORITE EFFECT  | 1998-1999 |        | JUC10  | PALE GREY             |
| MDZ  | PLATINUM EFFECT   | 2000-2005 | X-TYPE | JUC10  | PALE GREY             |
|  |   | 2000-2005 | XJ     | JUC10  | PALE GREY             |
|  |   | 2000-2005 | XK     | JUC10  | PALE GREY             |
|  |   | 2000-2005 | X-TYPE | JUC10  | PALE GREY             |
| MEA  | MIRAGE (NEUTRAL) SILVER EFFECT  | 2003      |        | JUC10  | PALE GREY             |
| MEE  | LIQUID SILVER EFFECT  | 2006-2008 | S-TYPE | JUC87  | LIQUID SILVER/ZERMATT |
|  |   | 2006-2011 | XJ     | JUC87  | LIQUID SILVER/ZERMATT |
|  |   | 2006-2011 | XK     | JUC87  | LIQUID SILVER/ZERMATT |
|  |   | 2006-2011 | X-TYPE | JUC87  | LIQUID SILVER/ZERMATT |
| NDE/NEE  | SPINDRIFT   | 2000-2001 | X-TYPE | JUC04  | WHITE                 |
|  |   | 2000-2001 | X-TYPE | JUC06  | WHITE                 |
| NDM  | SPINDRIFT WHITE   | 1996-1998 | S-TYPE | JUC03  | WHITE                 |
| NDP  | GLACIER WHITE   | 1988-1995 | S-TYPE | JUC03  | WHITE                 |
|  |   | 1988-1993 | XJ     | JUC03  | WHITE                 |
|  |   | 1991      | XK     | JUC03  | WHITE                 |
| NDP  | GLACIER WHITE   | 1988-1993 | X-TYPE | JUC03  | WHITE                 |
| NEF  | PORCELAIN (WARM WHITE)  | 1999-2000 | X-TYPE | JUC03  | WHITE                 |
| NEG  | ONYX WHITE  | 2002-2006 | S-TYPE | JUC04  | WHITE                 |
|  |   | 2002      | X100   | JUC06  | WHITE                 |
|  |   | 2002      | X200   | JUC03  | WHITE                 |
|  |   | 2002      | X300   | JUC03  | WHITE                 |
|  |   | 2002-2006 | XJ     | JUC03  | WHITE                 |
|  |   | 2002-2006 | XK     | JUC03  | WHITE                 |
|  |   | 2001-2007 | X-TYPE | JUC03  | WHITE                 |
| NEL  | PORCELAIN WHITE   | 2007-2008 | S-TYPE | JUC98  | PORCELAIN             |
|  |   | 2007-2010 | XJ     | JUC98  | PORCELAIN             |
|  |   | 2007-2010 | XK     | JUC98  | PORCELAIN             |
|  |   | 2007-2008 | X-TYPE | JUC98  | PORCELAIN             |
| PDD/PED  | ANTHRACITE EFFECT   | 2002      | X100   | JUC20  | BLACK                 |
|  |   | 2002      | X200   | JUC20  | BLACK                 |
|  |   | 2002      | X300   | JUC20  | BLACK                 |
|  |   | 2002      | X400   | JUC20  | BLACK                 |
|  |   | 2000-2002 | X-TYPE | JUC20  | BLACK                 |
| PDT  | BLACK   | 1994      | S-TYPE | JUC20  | BLACK                 |
|  |   | 1994      | XJ     | JUC20  | BLACK                 |
|  |   | 1994      | XK     | JUC20  | BLACK                 |
| PDV  | NAUTILUS (BLUE/BLACK) EFFECT  | 1996-1998 |        | JUC26  | MID BLUE GREY         |
|  |   | 1996-199  |        | JUC26  | MID BLUE GREY         |
| PDX  | ANTHRACITE BLACK EFFECT   | 1997-1998 | S-TYPE | JUC20  | BLACK                 |
| PEC  | EBONY   | 2003-2008 | S-TYPE | JUC20  | BLACK                 |
|  |   | 2003-2008 | XJ     | JUC20  | BLACK                 |
|  |   | 2003-2008 | XK     | JUC20  | BLACK                 |
|  |   | 2003-2008 | X-TYPE | JUC20  | BLACK                 |
| PEF  | MIDNIGHT (BLUE BLACK) EFFECT  | 2004      | X100   | JUC20  | BLACK                 |
|  |   | 2004      | X200   | JUC20  | BLACK                 |
|  |   | 2004      | X350   | JUC20  | BLACK                 |
|  |   | 2003-2008 | S-TYPE | JUC20  |                       |
|  |   | 2003-2008 | XJ     | JUC20  | BLACK                 |
|  |   | 2003-2008 | XK     | JUC20  | BLACK                 |
|  |   | 2003-2008 | X-TYPE | JUC20  |                       |
| SDL  | ROSE BRONZE EFFECT  | 1994-1995 | S-TYPE | JUC13  | MID BEIGE             |
|  |   | 1994-1995 | XJ     | JUC13  | MID BEIGE             |
|  |   | 1994-1995 | XK     | JUC13  | MID BEIGE             |
| SDN  | PALE BEIGE EFFECT   | 1995-1998 |        | JUC15  | DARK BLUE GREY        |
|  |   | 1995-1998 |        | JUC21  | LIGHT BEIGE GREY      |
| SEC  | TOPAZ EFFECT  | 2002-2004 | X100   | JUC60  | BEIGE                 |
|  |   | 2002-2004 | X200   | JUC60  | BEIGE                 |
|  |   | 2002      | X300   | JUC60  | BEIGE                 |
|  |   | 2004      | X350   | JUC60  | BEIGE                 |
|  |   | 2002      | X400   | JUC60  | BEIGE                 |
|  |   | 2002-2005 | S-TYPE | JUC21A   | LIGHT BEIGE/GREY      |
|  |   | 2002-2005 | XJ     | JUC21A   | LIGHT BEIGE/GREY      |
|  |   | 2002-2005 | XK     | JUC21A   | LIGHT BEIGE/GREY      |

# RELATED COLORS / ANBAUTEILFARBTOENE

|  |  | MODELYEAR | MODEL  |  |                  |
|--|---|-----------|--------|--|------------------|
| SHE  | ALTERNATIVE TOPAZ EFFECT  | 2001-2003 | X-TYPE | JUC21A   | LIGHT BEIGE/GREY |
| UDB  | BRIGHT TURQUOISE EFFECT   | 1995      | S-TYPE | JUC22  | TURQUOISE        |
|  |   | 1995      | XJ     | JUC22  | TURQUOISE        |
|  |   | 1995      | XK     | JUC22  | TURQUOISE        |

# RELATED COLORS / ANBAUTEILFARBTOENE

|  |  | MODELYEAR | MODEL   |  |              |
|--|---|-----------|---------|--|--------------|
| 859  | ANTHRACITE EFFECT   | 1996      | S-TYPE  | JSC851/LGA   | GREY         |
| 1712   | WESTMINSTER BLUE  | 2002      | XJ8     | JSC156/JEK   | MID BLUE     |
|  |   | 2000      | S-TYPE  | JSC156/JEK   | MID BLUE     |
| 1732   | SPINDRIFT   | 2004      | DAIMLER | JSC158.PEB   | BLACK CHERRY |
|  |   | 2000      | S-TYPE  | JSC851/LGA   | GREY         |
| 1753   | BRITISH RACING GREEN  | 2002      | XJ8/XJR | JSC155/HGA   | LIGHT BEIGE  |
| 1806   | SAPPHIRE EFFECT   | 2004      | XJ8/XJR | JSC154/JEL   | LIGHT BLUE   |
| 1810   | TITANIUM EFFECT   | 2002      | DAIMLER | JSC156/JEK   | MID BLUE     |
|  |   | 2000      | S-TYPE  | JSC156/JEK   | MID BLUE     |
| 1811   | CARNIVAL RED EFFECT   | 2002      | S-TYPE  | JSC153/AER   | CREAM        |
|  |   | 2002      | XJ      | JSC153/AER   | CREAM        |
|  |   | 2002      | XK      | JSC153/AER   | CREAM        |
| 1820   | TOPAZ EFFECT  | 2000-2003 | XJ8     | JSC158.PEB   | BLACK CHERRY |
|  |   | 2000-2003 | XJR     | JSC158.PEB   | BLACK CHERRY |
|  |   | 2000-2003 | S-TYPE  | JSC158.PEB   | BLACK CHERRY |
| 1823   | SPRUCE GREEN EFFECT   | 1998-2000 | XJ8     | JSC155/HGA   | LIGHT BEIGE  |
| 1835   | SHERWOOD GREEN EFFECT   | 2002      | XJ8     | JSC153/AER   | CREAM        |
| 1839   | AQUAMARINE EFFECT   | 2002      | XJ      | JSC155/HGA   | LIGHT BEIGE  |
| 1840   | ANTIGUA BLUE EFFECT   | 2004      | XK      | JSC154/JEL   | LIGHT BLUE   |
| 1859   | ANTHRACITE EFFECT   | 2002      | X-TYPE  | JSC851/LGA   | GREY         |
| 1860   | SEAFROST EFFECT   | 2003      | DAIMLER | JSC158.PEB   | BLACK CHERRY |
|  |   | 2000      | S-TYPE  | JSC158.PEB   | BLACK CHERRY |
| 1861   | MISTRAL EFFECT  | 2002      | X-TYPE  | JSC851/LGA   | GREY         |
| 1880   | ALPINE EFFECT   | 2002      | X-TYPE  | JSC153/AER   | CREAM        |
| 1881   | MADEIRA EFFECT  | 2002      |         | JSC153/AER   | CREAM        |
| 1882   | DARK PURPLE   | 2002      |         | JSC156/JEK   | MID BLUE     |
| 1895   | EMERALD (DEEP) GREEN EFFECT   | 2002      | XJ      | JSC155/HGA   | LIGHT BEIGE  |
| 1898   | JUPITER   | 2004      | XJ8/XJR | JSC158.PEB   | BLACK CHERRY |
| 1905   | PACIFIC/LAZURITE(NEUTRAL)BLUE EFFECT  | 2004      | XJ8/XJR | JSC154/JEL   | LIGHT BLUE   |
| 1916   | PLATINUM EFFECT   | 2004      | DAIMLER | JSC158.PEB   | BLACK CHERRY |
|  |   | 2000      | S-TYPE  | JSC158.PEB   | BLACK CHERRY |
| 1942   | ONYX WHITE  | 2002-2004 | X100    | JSC154/JEL   | LIGHT BLUE   |
|  |   | 2002-2004 | X200    | JSC154/JEL   | LIGHT BLUE   |
|  |   | 2002-2004 | X300    | JSC154/JEL   | LIGHT BLUE   |
|  |   | 2002-2004 | X400    | JSC154/JEL   | LIGHT BLUE   |
|  |   | 2002-2006 | XJ      | JSC154/JEL   | LIGHT BLUE   |
|  |   | 2002-2006 | XK      | JSC154/JEL   | LIGHT BLUE   |
|  |   | 2001-2007 | X-TYPE  | JSC154/JEL   | LIGHT BLUE   |
| CGG  | CARNIVAL RED EFFECT   | 2002      | S-TYPE  | JSC153/AER   | CREAM        |
|  |   | 2002      | XJ      | JSC153/AER   | CREAM        |
|  |   | 2002      | XK      | JSC153/AER   | CREAM        |
| CGH  | MADEIRA EFFECT  | 2002      |         | JSC153/AER   | CREAM        |
| CGJ  | JUPITER   | 2003      | XJ8/XJR | JSC158.PEB   | BLACK CHERRY |
| HGD  | BRITISH RACING GREEN  | 2002      | XJ8/XJR | JSC155/HGA   | LIGHT BEIGE  |
| HGE  | SHERWOOD GREEN EFFECT   | 2002      | XJ8     | JSC153/AER   | CREAM        |
| HGF  | ALPINE EFFECT   | 2002      | X-TYPE  | JSC153/AER   | CREAM        |
| HGG  | EMERALD (DEEP) GREEN EFFECT   | 2002      | XJ      | JSC155/HGA   | LIGHT BEIGE  |
| HGL  | SPRUCE GREEN EFFECT   | 1998-2000 | XJ8     | JSC155/HGA   | LIGHT BEIGE  |
| JHE  | SAPPHIRE EFFECT   | 2004      | XJ8/XJR | JSC154/JEL   | LIGHT BLUE   |
| JHF  | AQUAMARINE EFFECT   | 2002      | XJ      | JSC155/HGA   | LIGHT BEIGE  |
| JHG  | WESTMINSTER BLUE  | 2002      | XJ8     | JSC156/JEK   | MID BLUE     |
|  |   | 2000      | S-TYPE  | JSC156/JEK   | MID BLUE     |
| JHH  | ANTIGUA BLUE EFFECT   | 2004      | XK      | JSC154/JEL   | LIGHT BLUE   |
| JHJ  | MISTRAL EFFECT  | 2002      | X-TYPE  | JSC851/LGA   | GREY         |
| JHM  | PACIFIC/LAZURITE(NEUTRAL)BLUE EFFECT  | 2003      | DAIMLER | JSC154/JEL   | LIGHT BLUE   |
| KDL  | DARK PURPLE   | 2002      |         | JSC156/JEK   | MID BLUE     |
| LGL  | TITANIUM EFFECT   | 2002      | DAIMLER | JSC156/JEK   | MID BLUE     |
|  |   | 2000      | S-TYPE  | JSC156/JEK   | MID BLUE     |
| MDV  | SEAFROST EFFECT   | 2003      | DAIMLER | JSC158.PEB   | BLACK CHERRY |
|  |   | 2000      | S-TYPE  | JSC158.PEB   | BLACK CHERRY |
| MDZ  | PLATINUM EFFECT   | 2004      | DAIMLER | JSC158.PEB   | BLACK CHERRY |
|  |   | 2000      | S-TYPE  | JSC158.PEB   | BLACK CHERRY |
| NDE/NEE  | SPINDRIFT   | 2004      | DAIMLER | JSC158.PEB   | BLACK CHERRY |
|  |   | 2000      | S-TYPE  | JSC851/LGA   | GREY         |
| NEG  | ONYX WHITE  | 2002-2004 | X100    | JSC154/JEL   | LIGHT BLUE   |
|  |   | 2002-2004 | X200    | JSC154/JEL   | LIGHT BLUE   |
|  |   | 2002-2004 | X300    | JSC154/JEL   | LIGHT BLUE   |
|  |   | 2002-2004 | X400    | JSC154/JEL   | LIGHT BLUE   |
|  |   | 2002-2006 | XJ      | JSC154/JEL   | LIGHT BLUE   |
|  |   | 2002-2006 | XK      | JSC154/JEL   | LIGHT BLUE   |
|  |   | 2001-2007 | X-TYPE  | JSC154/JEL   | LIGHT BLUE   |
|  |   | 2002      | XJ      | JSC154/JEL   | LIGHT BLUE   |
| PDD/PED  | ANTHRACITE EFFECT   | 2002      | DAIMLER | JSC851/LGA   | GREY         |
|  |   | 2000      | S-TYPE  | JSC851/LGA   | GREY         |
| PDX  | ANTHRACITE EFFECT   | 1996      | S-TYPE  | JSC851/LGA   | GREY         |
| SEC  | TOPAZ EFFECT  | 2000-2003 | XJR     | JSC158.PEB   | BLACK CHERRY |
|  |   | 2000-2003 | S-TYPE  | JSC158.PEB   | BLACK CHERRY |